

## Final Review 8th

<b><u>Vocabulary</u></b>	<b><u>Formulas</u></b>
<ol style="list-style-type: none"><li>1. Slope</li><li>2. Y-intercept</li><li>3. Linear</li><li>4. Area</li><li>5. Rational</li><li>6. Irrational</li><li>7. "Expand" AKA Distribute</li><li>8. Reflection</li><li>9. Translation</li></ol>	<ol style="list-style-type: none"><li>1. Slope</li><li>2. Area<ol style="list-style-type: none"><li>a. Rectangles</li><li>b. Triangles</li></ol></li><li>3. Volume<ol style="list-style-type: none"><li>a. Cube</li><li>b. Rectangular prism</li><li>c. Rectangular pyramid</li><li>d. Cylinder</li><li>e. Cone</li><li>f. Sphere</li></ol></li><li>4. Pythagorean theorem<ol style="list-style-type: none"><li>a. Distance formula</li></ol></li><li>5. Double Distribution- FOIL</li></ol>

### **Sample Problems**

1. Find the slope of a line passing through (3, 5) and (-2, 4)
2. Identify the slope and y-intercept given  $y = 2x - 4$ . Graph the line.
3. Identify the slope and y-intercept given  $y = x + 7$ . Graph the line.
4. Write the equation of a line passing through (2,-3) and (5,4).
5. The area of a square sign is  $32in^2$  what are the side lengths. Round to the nearest tenth as necessary.
6. Evaluate  $\sqrt{25} + \sqrt{144}$
7. Between what two consecutive numbers would  $\sqrt{30}$  be found?
8. Place the following numbers on a number line:  $1, \frac{1}{5}, \frac{3}{8}, 1\frac{7}{9}, 2$
9. The volume of a cube is  $125 cm^3$ . What is the length of each side?
10. Solve  $\sqrt[3]{729}$
11.  $x^3 = 512$
12. Find the distance between (3,4) and (7, 9). Round to the nearest 10th if necessary.
13. Is  $\sqrt{121}$  rational or irrational?
14. Is  $\sqrt{70}$  rational or irrational?
15. Expand  $4(x - 5)$ .
16. If the length of a rectangle is  $(2x - 5)$  and the width is  $(x + 3)$  what is the perimeter of the rectangle?

17. Write the equation on the line graphed below. Write in slope-intercept form.

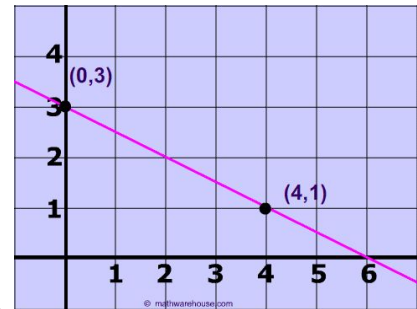
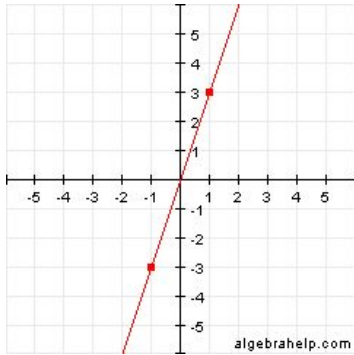

18. Identify the y-intercept and slope given the graph below.

19. I joined a yoga club. The membership fee is \$25 a month and then each class costs \$5. Write an equation for the total cost per month, where  $x$  is the number of classes I take and  $y$  is the total cost.

a. Last month my bill was \$80, how many classes did I go to?

20. I'm using cube pavers in my driveway. The website I'm buying from says they have a volume of  $\frac{27}{125}ft^3$  what is the measure of each of the sides of the cube?

21. Find the volume of the shapes below.

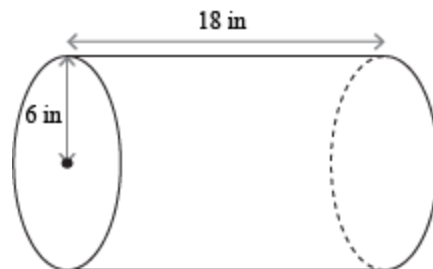
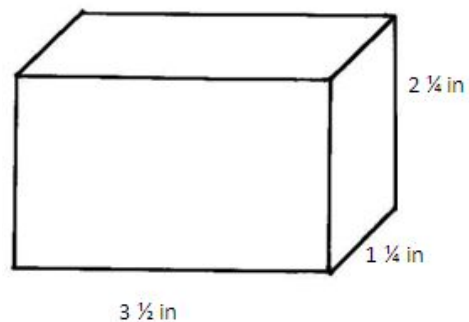
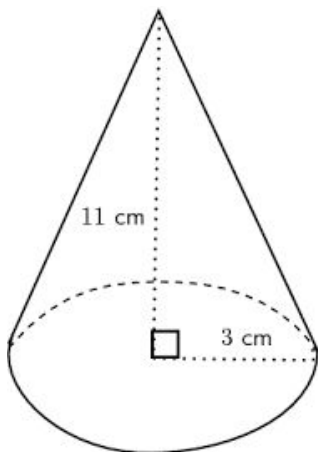

22. Find the area of the following composite

figures

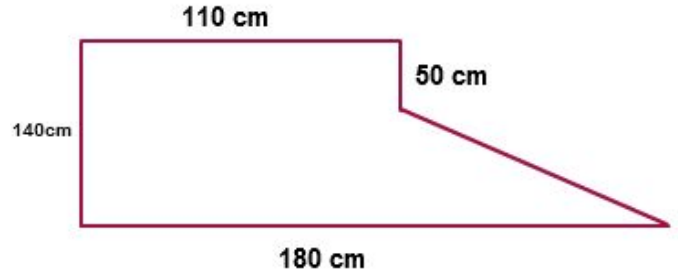
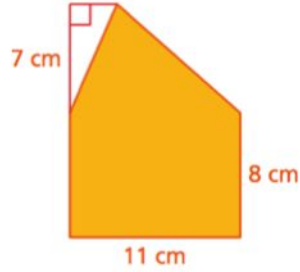
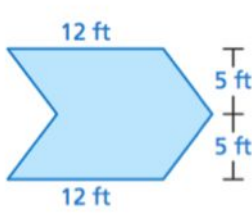

23. Use Pythagorean theorem to solve for the missing side.

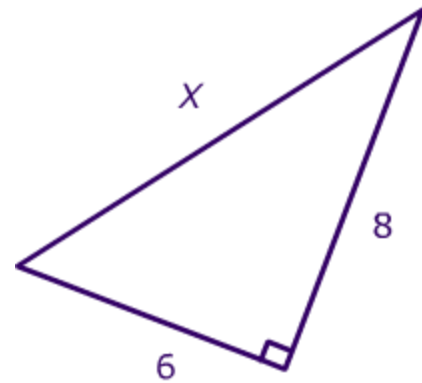
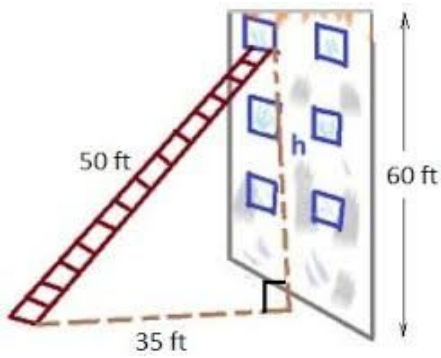

[www.mathwarehouse.com](http://www.mathwarehouse.com)

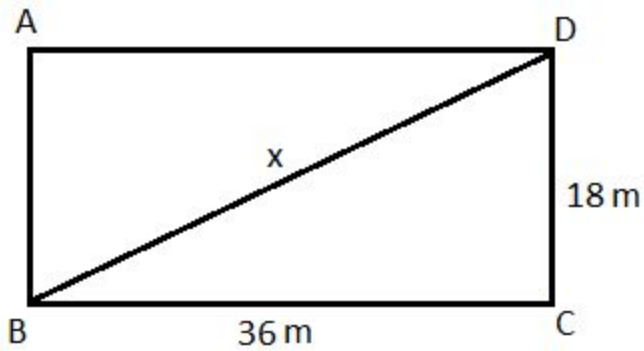

24. Find the slant height of the pyramid.

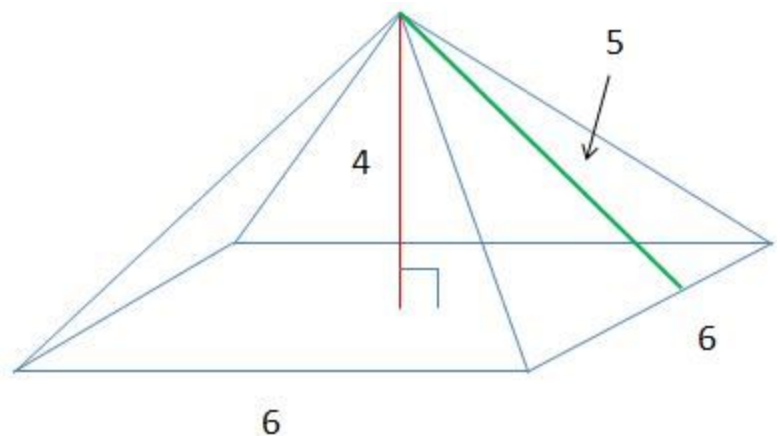

25. I need to go up on the roof, which is 25ft high. I need to position my ladder 10ft away from the house to get a good footing. How tall will the ladder need to be to reach the roof?

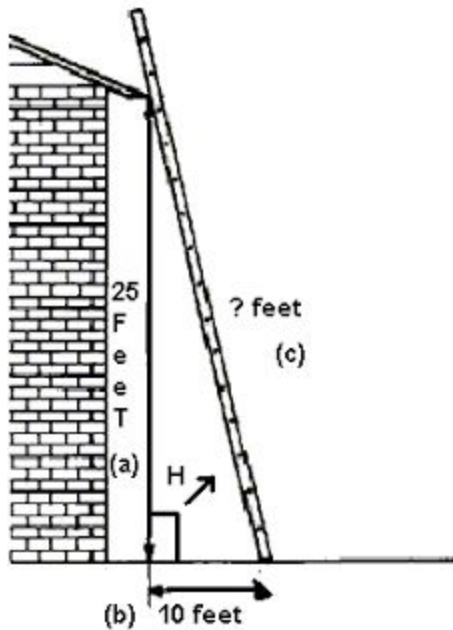

26. Find the distance between the points.

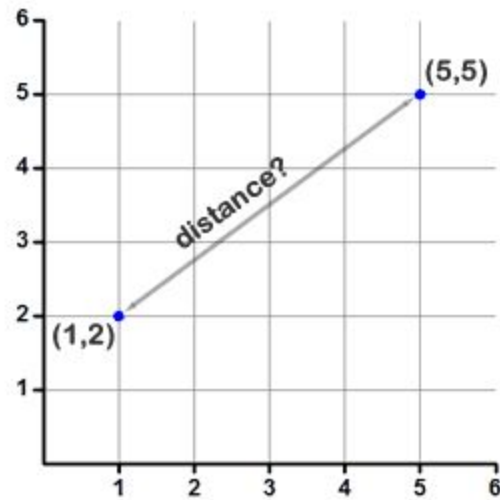
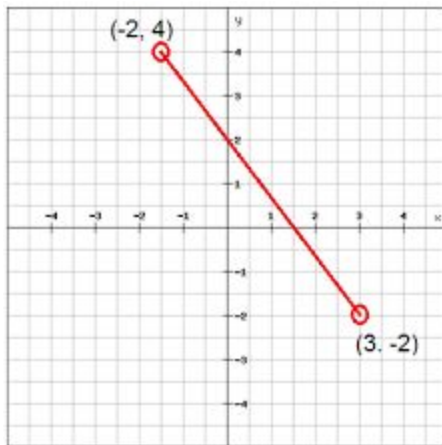

27. Is this a right triangle?

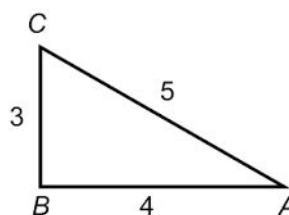

28. Find the volume of the sphere.

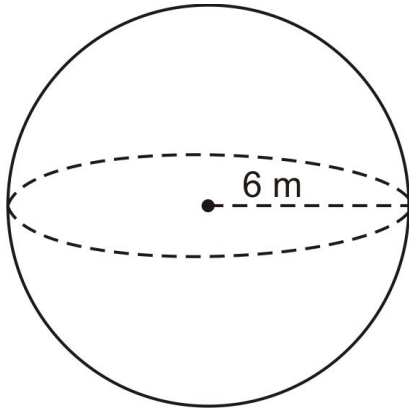

29. Find the solution to the system of equations

a.  $y = 2x + 5$  and  $2x - 3y = 9$

b.  $3x + y = 6$  and  $3x - 4y = 1$

30. Circle the image that shows  $WXYZ$  reflected over the x-axis

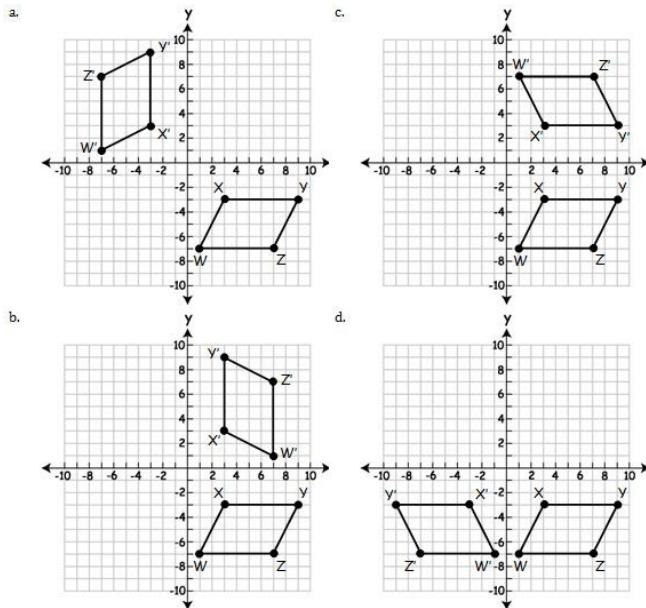

31. In the above image which shows  $WXYZ$  reflected over the y-axis?

32. Translate a triangle with vertices at  $A(1, 2)$ ,  $B(3, 4)$  and  $C(5, 6)$  3 units right and 5 units down (draw or just identify  $A'$ ,  $B'$  and  $C'$ ).